

Greenroom

Advantages

- *FORTS are the ideal solution for greenrooms*
- *16ft wide footprint to maximize furniture layout*
- *Ability to expand the footprint to accommodate as many people as necessary*
- *Climate-controlled for optimal comfortability*
- *Keypad lock system*
- *Multi-Room layouts to maximize privacy and efficiency*
- *Adaptable design allows for optimal privacy*
- *Optional furniture packages*
- *Flexible layouts for interior/exterior, entrance and windows*
- *Built-in Coax & HDMI connections*
- *Secure storage options*
- *Ramp and step options*

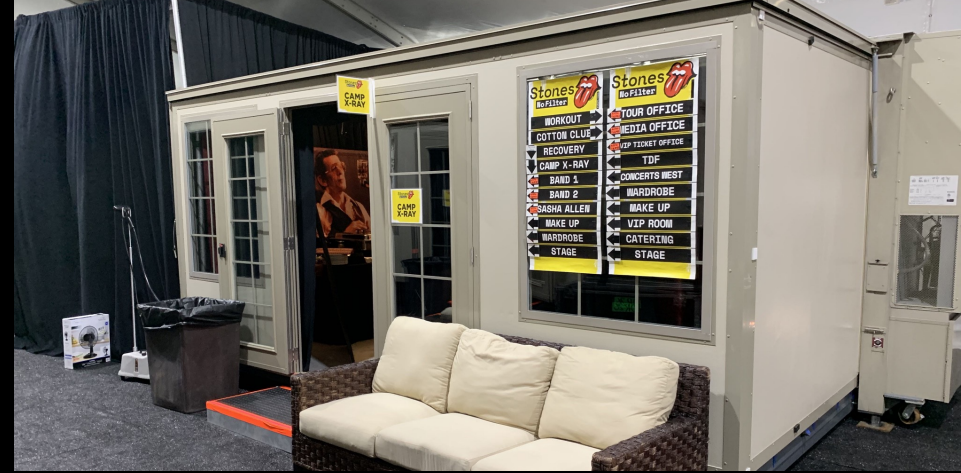

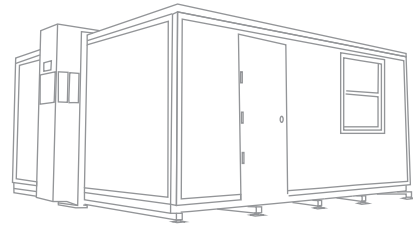

Up To 180 Mph

Up To 4 FORTS Units Per Truck

Leveled+ Assembled On Any Surface

Built-in HVAC, Lighting, Data, Power Outlets

Energy Efficiency + Environmentally Friendly

Rapid 15 Minutes Set-up

Easily Maneuverable

4,000 lbs per FORTS Unit

Branding Options Available

FORTS SYSTEMS

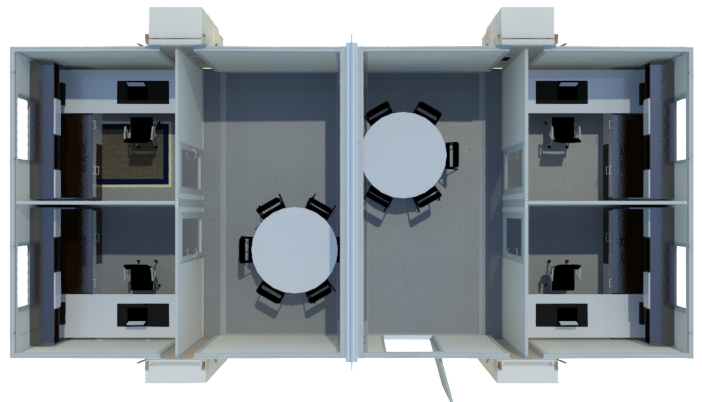

MULTIPLE INTERIOR LAYOUT OPTIONS

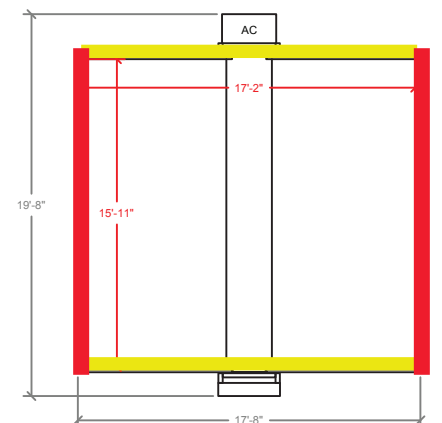

SINGLE UNIT

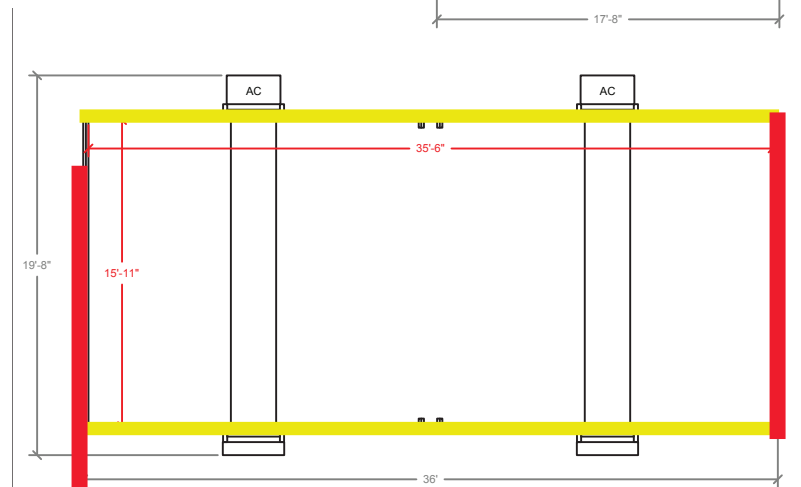

TANDEM

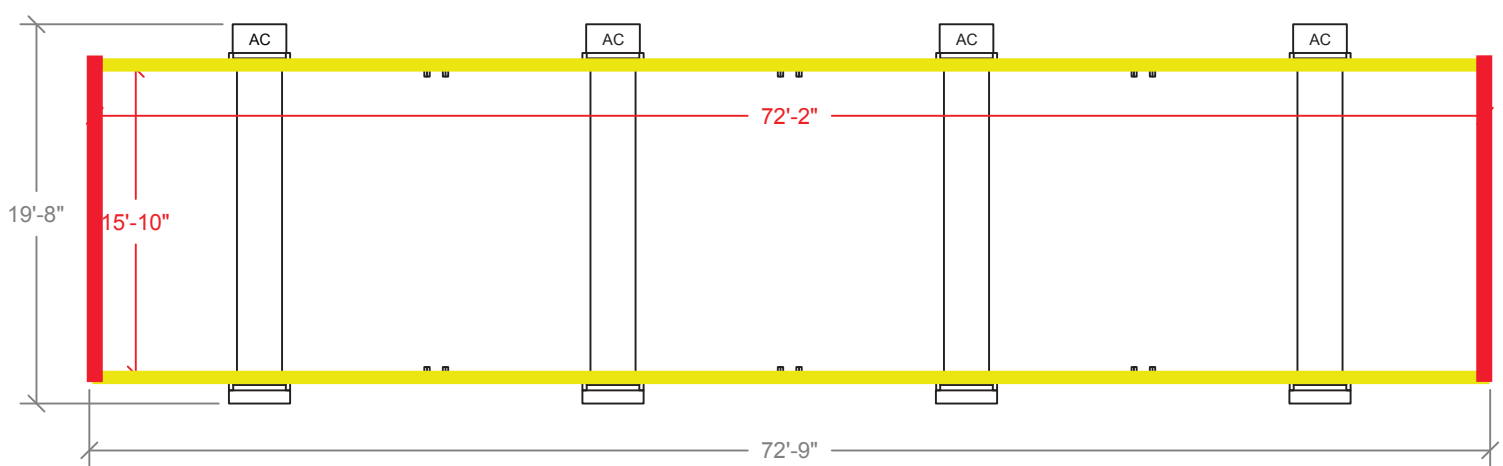
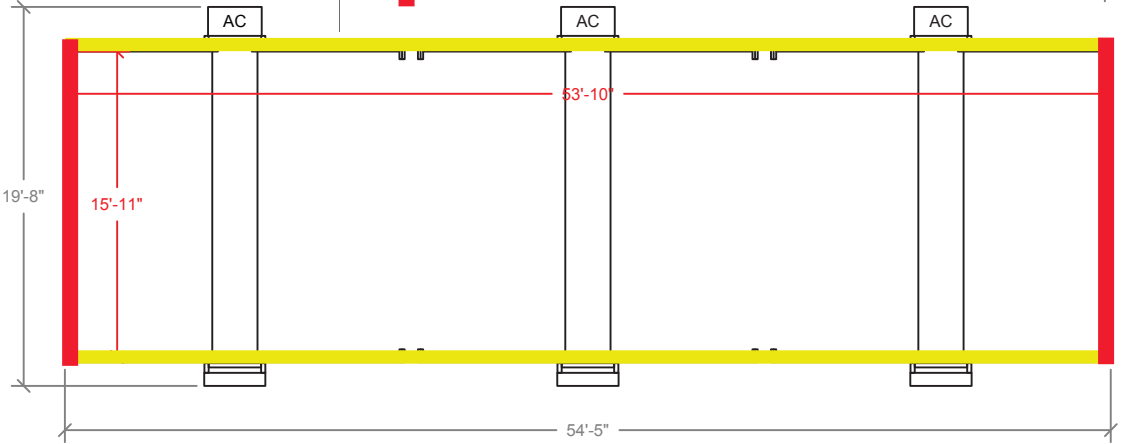

ALPHA WALL



BETA WALL

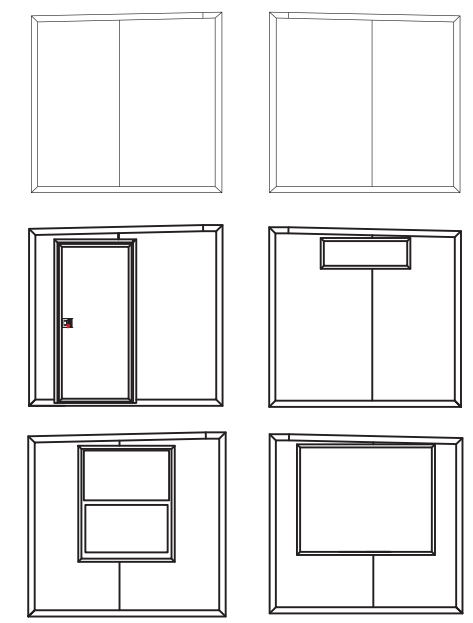

CONTACT US (786) 942 - 4389 | info@fortsservices.com | fortsservices.com