

“Glamping”

Advantages

- A 5-star experience in any environment
- Multi-Room layouts to maximize privacy and efficiency
- Decoration and furniture turnkey packages allow for luxury feel
- Adaptable design allows for optimal privacy
- Climate controlled units allow for escape from outside elements
- Flexible layouts for interior/exterior, entrance and windows
- 16ft wide footprint to maximize furniture layout
- Built-in Coax & HDMI connections
- Ability to expand the footprint to accommodate as many people as necessary
- Secure storage options
- Keypad lock system
- Ramp and step options

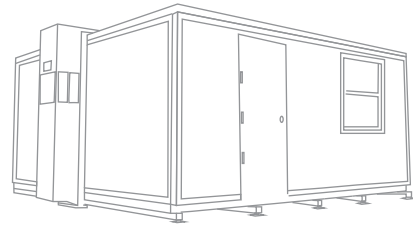



Up To 180 Mph

Up To 4 FORTS Units Per Truck

Leveled+ Assembled On Any Surface

Built-in HVAC, Lighting, Data, Power Outlets

Energy Efficiency + Environmentally Friendly

Rapid 15 Minutes Set-up

Easily Maneuverable

4,000 lbs per FORTS Unit

Branding Options Available

FORTS SYSTEMS

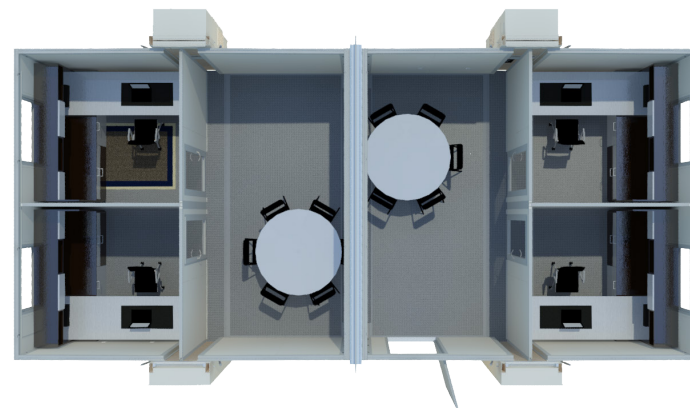

MULTIPLE INTERIOR LAYOUT OPTIONS

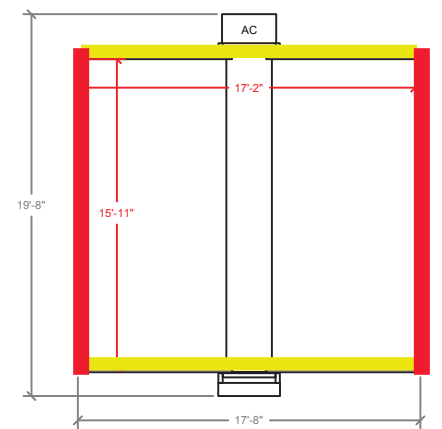

SINGLE UNIT

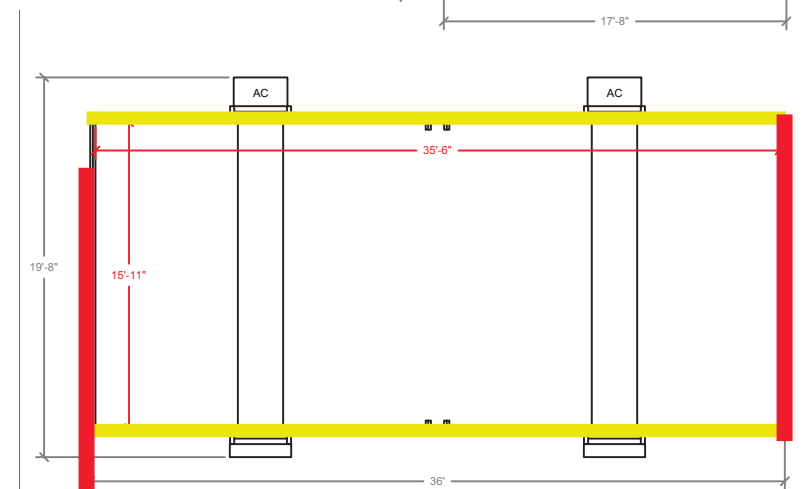

TANDEM

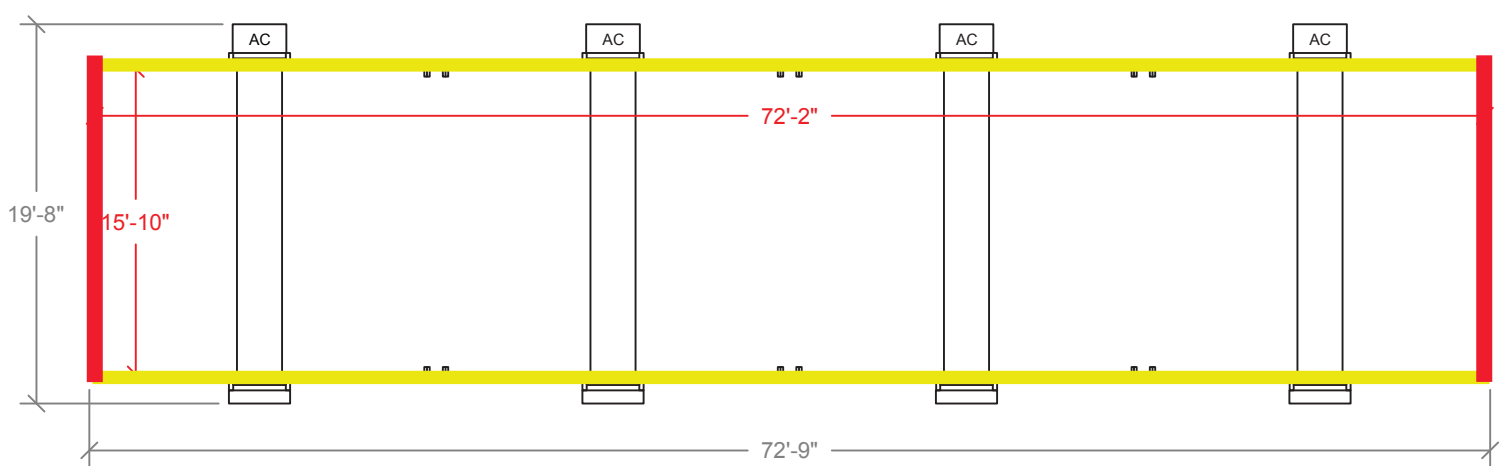
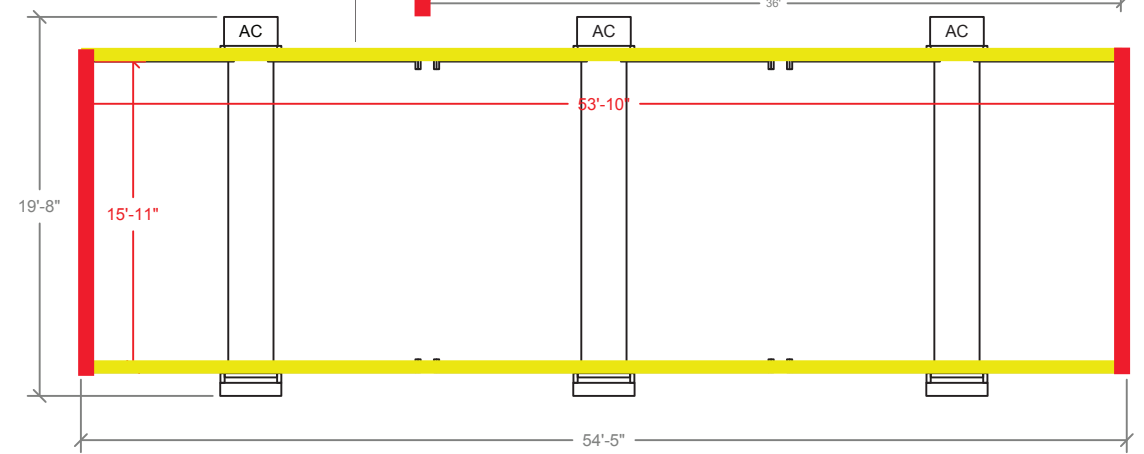

ALPHA WALL



BETA WALL

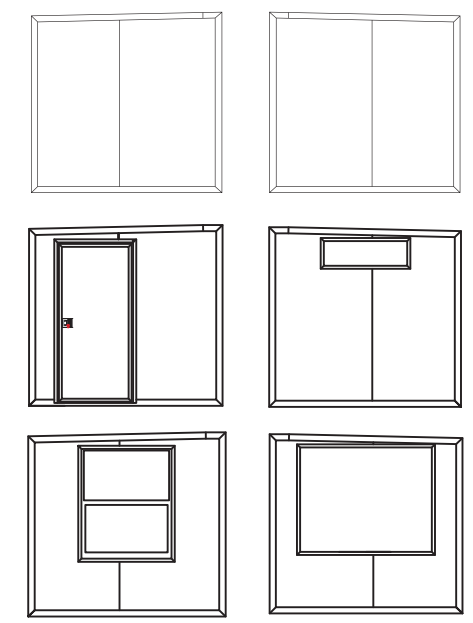

CONTACT US (786) 942 - 4389 | info@fortsservices.com | fortsservices.com