

Dressing Room

Advantages

- 16ft wide footprint to allow for an unapparelled feeling of comfort and luxury in a mobile structure
- Optional furniture packages
- Ability to expand the footprint to accommodate as many people as necessary
- Climate-controlled for optimal comfortability
- Keypad lock system
- Multi-Room layouts to maximize privacy and efficiency
- Adaptable design allows for optimal privacy
- Flexible layouts for interior/exterior, entrance and windows
- Built-in Coax & HDMI connections
- Secure storage options
- Ramp and step options

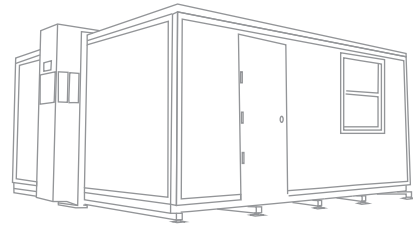



Up To 180 Mph

Up To 4 FORTS Units Per Truck

Leveled+ Assembled On Any Surface

Built-in HVAC, Lighting, Data, Power Outlets

Energy Efficiency + Environmentally Friendly

Rapid 15 Minutes Set-up

Easily Maneuverable

4,000 lbs per FORTS Unit

Branding Options Available

FORTS SYSTEMS

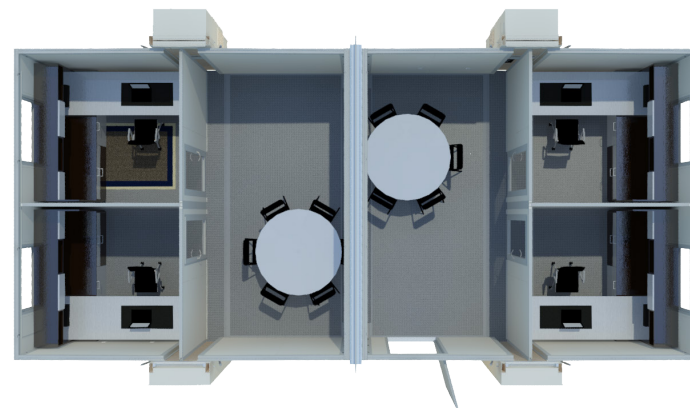

MULTIPLE INTERIOR LAYOUT OPTIONS

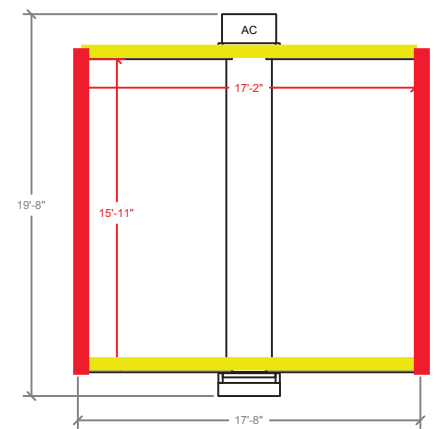

SINGLE UNIT

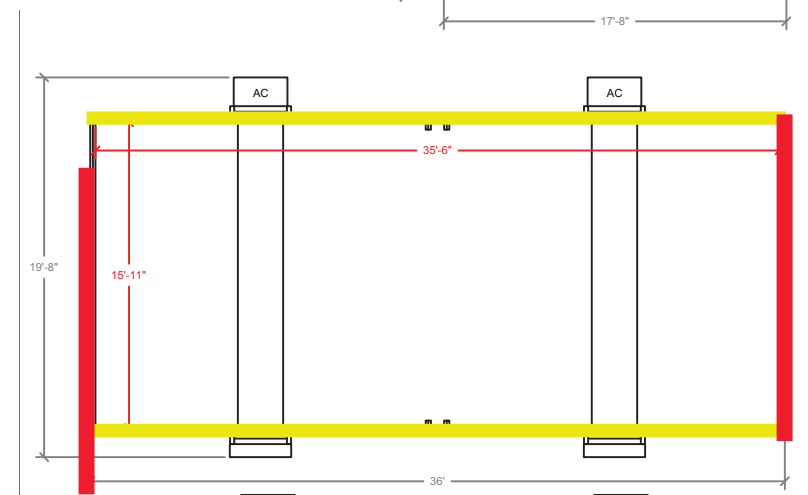

TANDEM

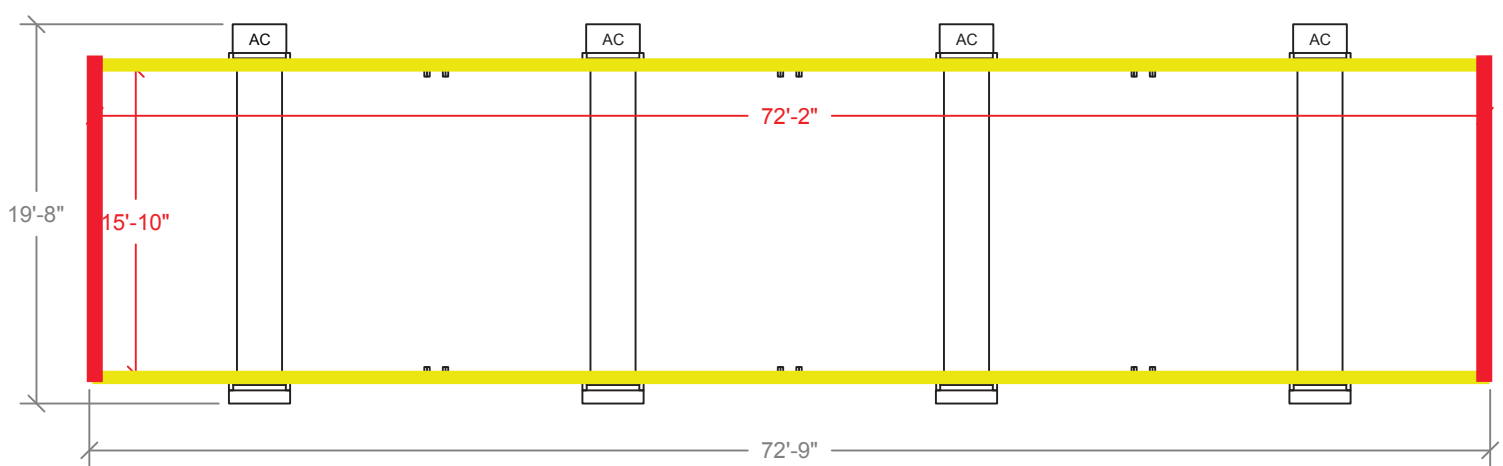
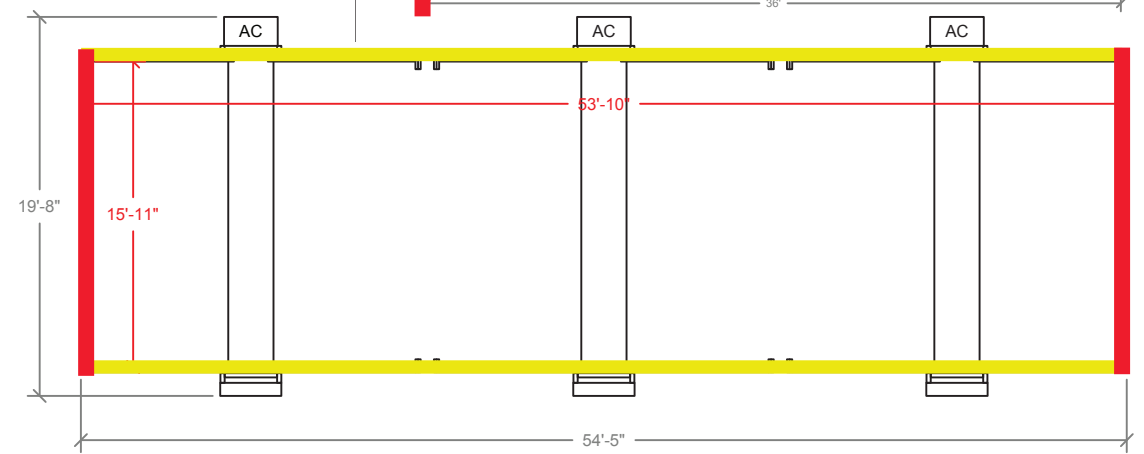

ALPHA WALL



BETA WALL

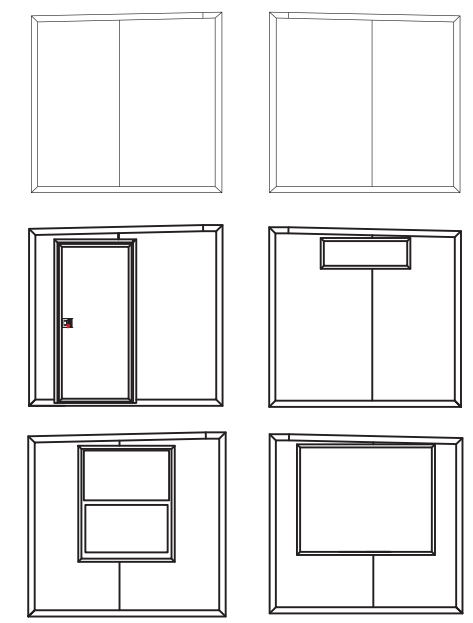

CONTACT US (786) 942 - 4389 | info@fortsservices.com | fortsservices.com