

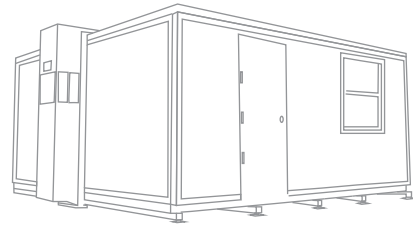

# Artist Village

## Advantages

- Turnkey compound within a day
- 16ft wide footprint to maximize furniture layout
- Reliability is one of our key differentiators from other providers
- Expandable to accommodate as many people as necessary
- Save money and time with up to 30 units deployed in one day with minimal labor
- Keypad lock system
- Optional furniture packages
- Flexible layouts for interior/exterior, entrance and windows
- Built-in Coax & HDMI connections
- Additional pass-throughs for large wires
- Secure storage options
- Ramp and step options



Up To 180 Mph

Up To 4 FORTS Units Per Truck

Leveled+ Assembled On Any Surface

Built-in HVAC, Lighting, Data, Power Outlets

Energy Efficiency + Environmentally Friendly

Rapid 15 Minutes Set-up

Easily Maneuverable

4,000 lbs per FORTS Unit

Branding Options Available

# FORTS SYSTEMS

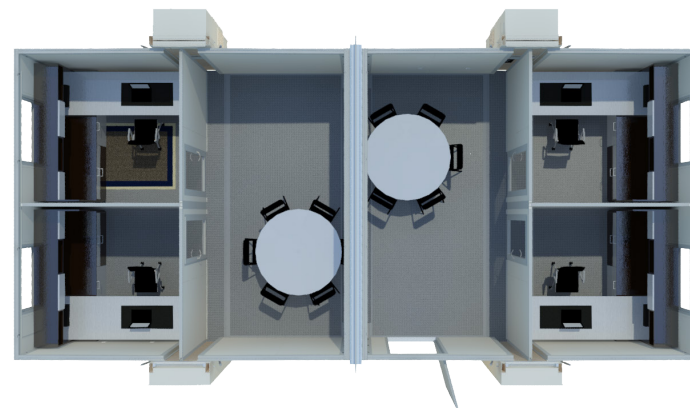

MULTIPLE INTERIOR LAYOUT OPTIONS

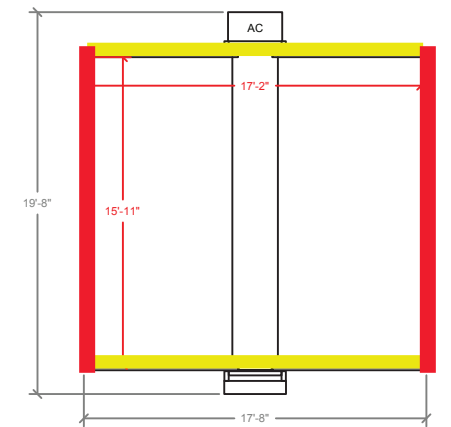

SINGLE UNIT

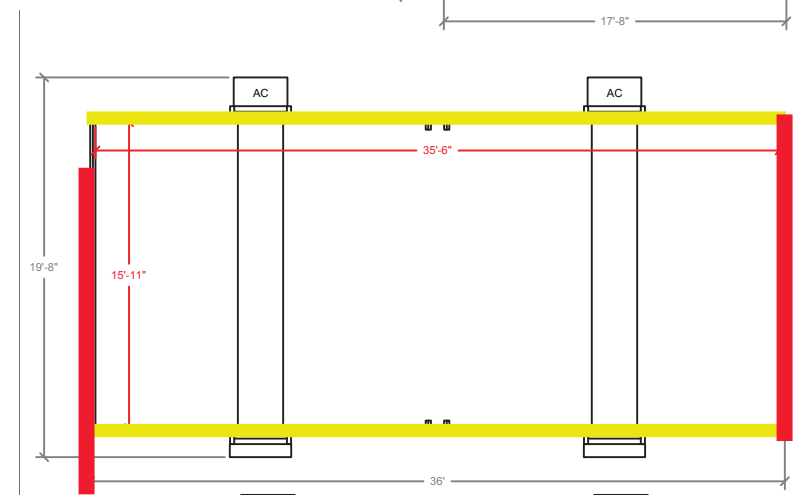

TANDEM

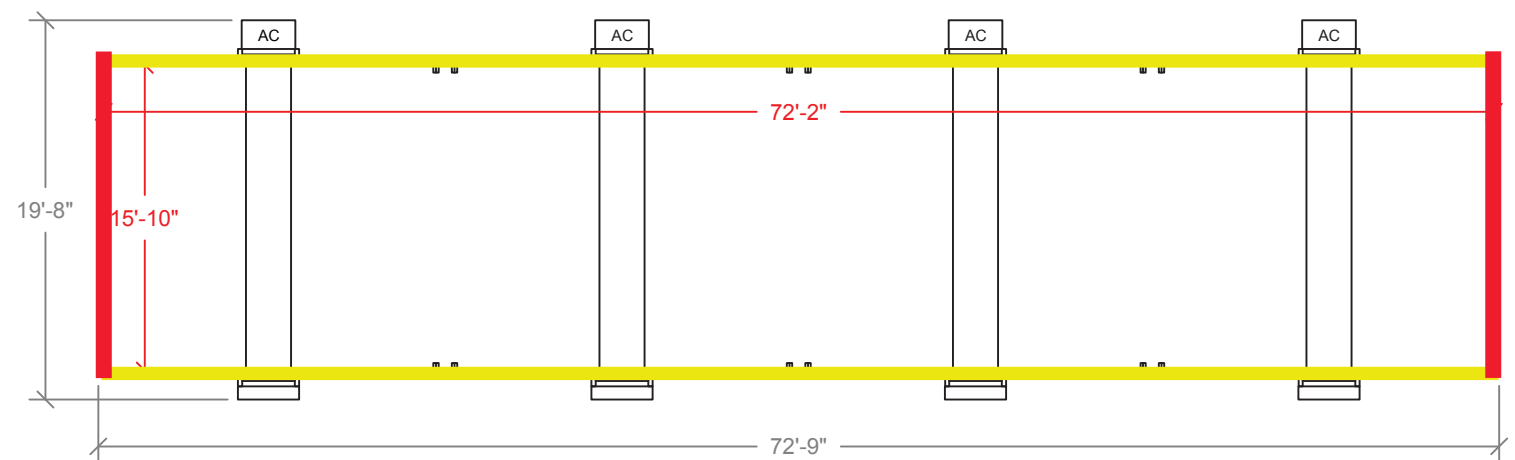
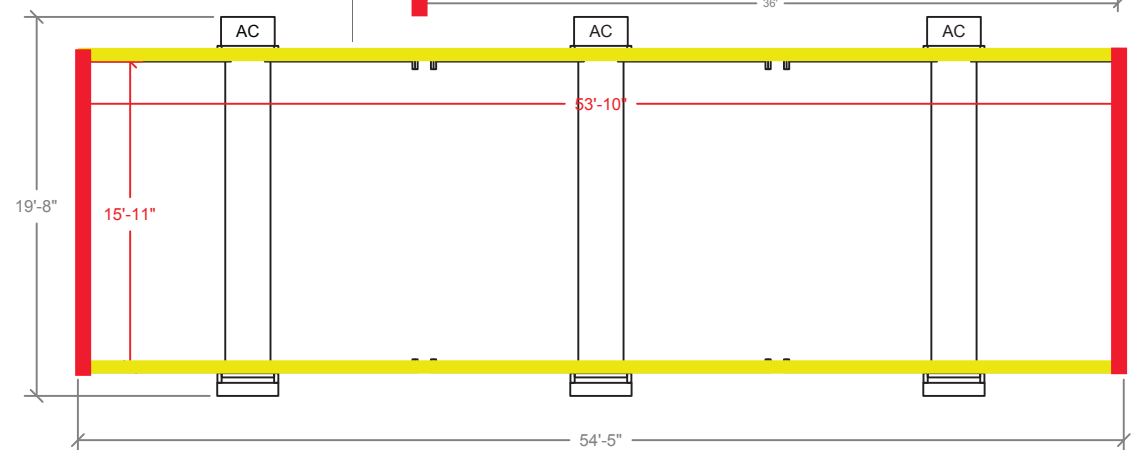

## ALPHA WALL



## BETA WALL

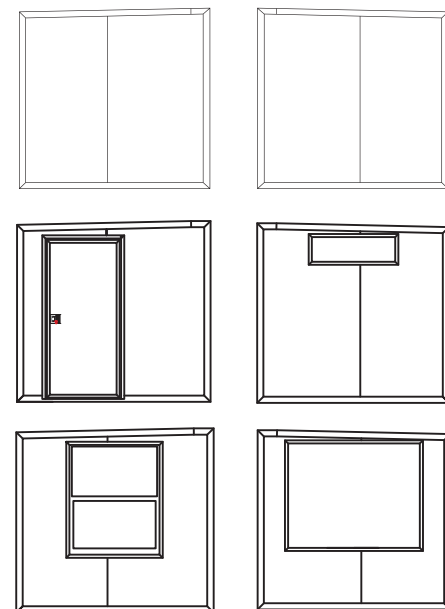

CONTACT US (786) 942 - 4389 | [info@fortsservices.com](mailto:info@fortsservices.com) | [fortsservices.com](http://fortsservices.com)